

PCU-X01 WirelessHART Sensor Hub

Description

Syscor's PCU-X01 WirelessHART Sensor Hub was developed and qualified, in close cooperation with the petroleum industry, as a versatile platform for facility integrity monitoring. The Intrinsically Safe PCU-X01 provides power and communication to attached sensor probes.

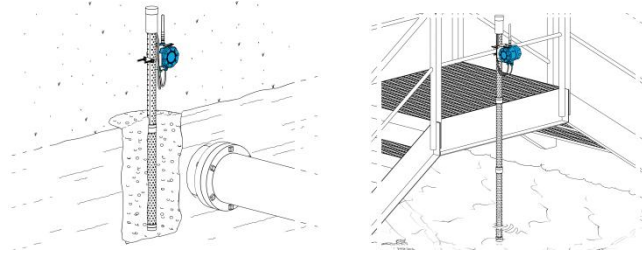

Figure 1. HC-Tracker monitoring well assembly

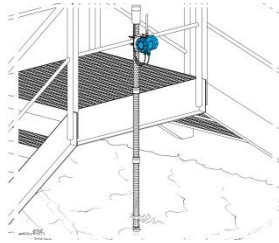

Figure 2. HC-Tracker water body monitoring assembly

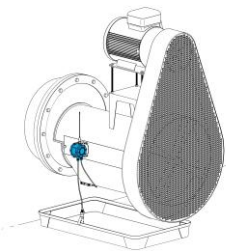

Figure 3. HC-Tracker tank mixer monitoring assembly

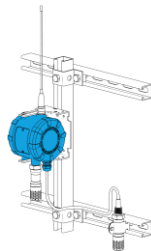

Figure 4. HC-Tracker sump monitoring assembly

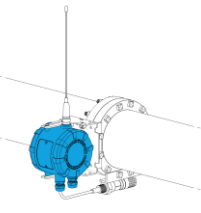

Figure 5. HC-Tracker pipe flange monitoring assembly

Applications

The PCU-X01 with sensor probes targets hydrocarbon leak detection applications underground, in water bodies, and on equipment such as sumps, tank mixers, piping flanges, vessel inlet/outlet piping, tank drains, interstitial spaces, outflow piping and more.

Power

The PCU-X01 is powered by a Syscor 841 or 902 battery pack. Both of these packs contain high energy density lithium thionyl chloride (Li-SOCl₂) cells. Low self-discharge provides 10+ years of reliable and predictable power, depending on the update rate.

Installation

The Sensor Hub can attach directly to equipment or structures with Syscor's Universal Mounting Bracket. No hot work is required. Optional bracket magnets can be used on flat steel surfaces.

Sensor Probes

Syscor's field replaceable HCD or HCDW Probes monitor hydrocarbons, acceleration/vibration, water level (HCDW only), and temperature. Up to two sensor probes may be used at a time with a PCU-X01.

WirelessHART Communication

The Sensor Hub utilizes the industry standard WirelessHART protocol, which accounts for roughly 30% of the industrial wireless sensing market.* Data is transmitted from the WirelessHART Gateway to the facility's DCS/SCADA using standard industrial interfaces and protocols. WirelessHART (IEC 62591) is a secure, full mesh technology capable of self-forming, healing, and scaling.

* <https://www.controlglobal.com/articles/2019/arc-report-details-growth-of-fspan-stylefont-size-x-smalloundationspan-fieldbus-hart-and-emwirelessemhart/>

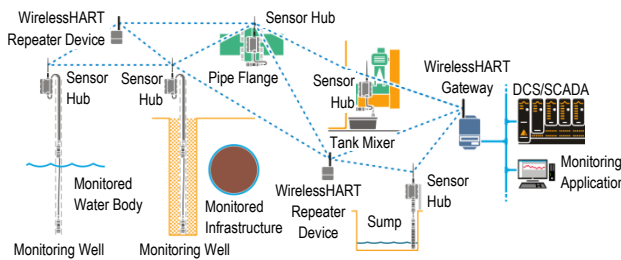
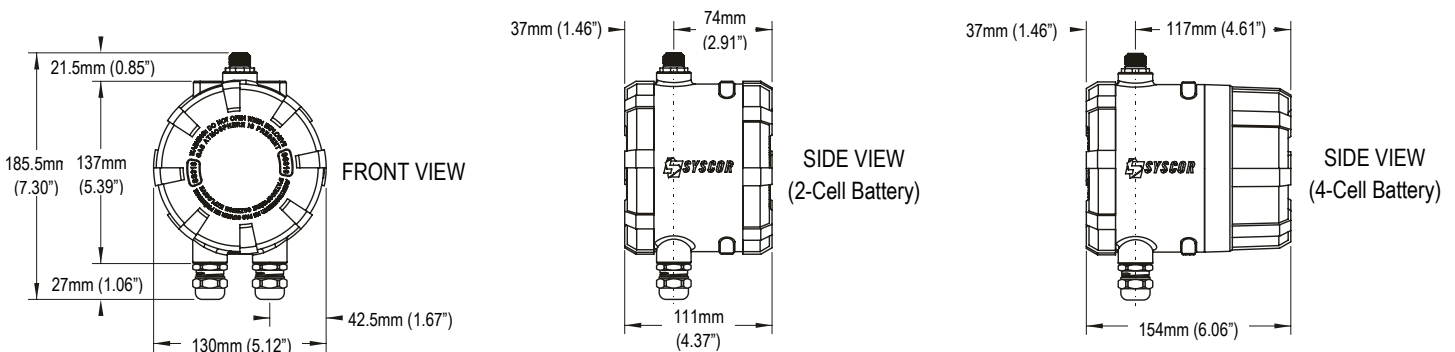

Figure 6. Sample WirelessHART network of devices monitoring various environments and equipment



Specifications

Functional Specifications

Internal Sensors	Vibration/accelerometer, electronics temperature
External Sensors	Syscor's HCD and HCDW Probes connect directly to the PCU-X01 Sensor Hub via 1/2in. NPT ports or can be mounted remotely with cable. If two sensor probes are used, total combined cable length for Intrinsically Safe operation cannot exceed 10m (33ft.).
Wireless.	WirelessHART IEC 62591 2.4 GHz DSSS
Wireless Data Update Rate	User-selectable; 5 seconds to 1 hour
Power Supply (Battery Pack)	Models available for use: <ul style="list-style-type: none"> - Model 841 Battery Pack: 2-cell, 7.2V 19.0Ah 136.8Wh (recommended for the PCU-X01) - Model 902 Battery Pack: 4-cell, 7.2V 38.0Ah 273.6Wh Battery packs are Li-SOCI2, field replaceable, Intrinsically Safe, and have 10+ years of battery life depending on application and update rate.
Communication	Maintenance Port for communication with HART field communicator

Physical Specifications

Enclosure	Stainless steel SS316. IP67, Type 4X Optional sensor probes are IP68, Type 4X
Antenna Port	N-Type female
Sensor Probe Ports	1/2in. NPT
Sensor Wiring Connections	Screw terminals
Weight	3.75kg [8.3lbs.]
Mounting Options	Universal Mounting Bracket with 2" or 5" U-bolt, or magnets.

Performance Specifications

Vibration and Acceleration	Ultra-low-power, high performance, three-axis linear accelerometer; Dynamically selectable range from 0g to 16g; Acceleration and velocity detection
Electronics Temperature	Integrated circuit sensing elements embedded inside, provide up to +/- 1°C [1.8°F]
Operating Temp.	-40°C to +60°C [-40°F to +140°F]

Certifications

USA	FCC: 2AAZE-000697 Intrinsic Safety: CSA 19CA70174889X Class I, Division 1, Groups C and D, T4 Class I, Zone 0 AEx ia IIB T4 Ga
Canada	IC: 11413A-000697 Intrinsic Safety: CSA 19CA70174889X Class I, Division 1, Groups C and D, T4 Ex ia IIB T4 Ga
Europe	Intrinsic Safety: SIRA 18ATEX2249X Ex ia IIB T4 Ga CE ₂₈₁₃
IECEx	Intrinsic Safety: IECEx CSA 18.0031X Ex ia IIB T4 Ga

Learn More

HCD Hydrocarbon Detector Probe	syscor.com/downloads/syscor_spec-sheet_hcd-probe_en_80169.pdf
HCDW Hydrocarbon Detector Probe with Water Level	syscor.com/downloads/syscor_spec-sheet_hcdw-probe_en_80171.pdf
Field Transmitter Battery Packs	syscor.com/downloads/syscor_spec-sheet_field-transmitter-battery-packs_en_80155.pdf
Antennas	syscor.com/products/antennas
Universal Mounting Bracket	syscor.com/downloads/syscor_spec-sheet_universal-mounting-bracket_en_80163.pdf
Floating Roof Bracket	syscor.com/downloads/syscor_spec-sheet_fr-mounting-bracket_en_80159.pdf
Stackable Monitoring Well	syscor.com/downloads/syscor_spec-sheet_stackable-monitoring-well_en_80185.pdf